

Article number: 2310431061S

Description: E+G Levelling elements
LX.30-SW17-M8X33-S

Measures

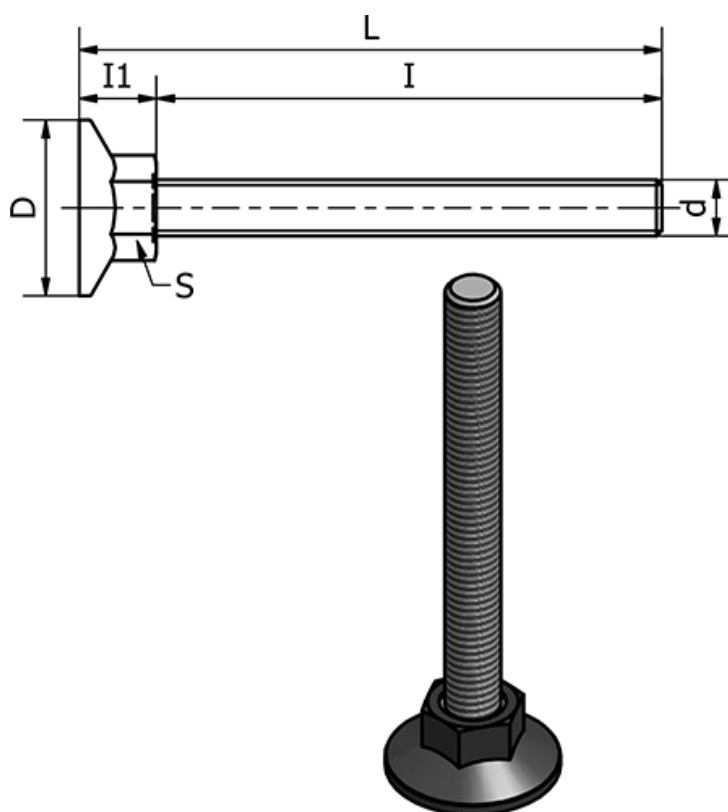

d	= M8
D	= 30
I	= 33
I1	= 12
L	= 45
S	= 17
Static load in (N)	= 2500
Type	= Forzinket

Weight (g) = -